

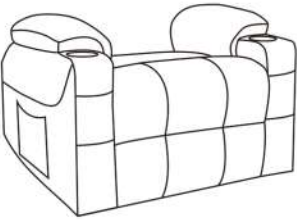

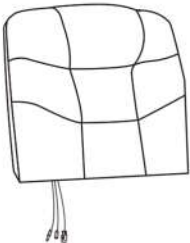



HUDSON

A 	B 	C 	D 	E 	F 	G 
Baza scaunului	Spătar	Cablu de alimentare	Telecomandă	Mufă	Sursa de alimentare	Telecomandă

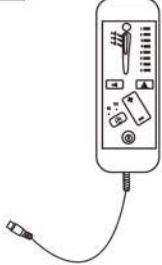

Firul nr. 1 se conectează cu spătarul și baza scaunului.
Firul nr. 2 se conectează cu spătarul și cablul de alimentare (C).
Firul nr. 3 se conectează cu spătarul și telecomanda (D).
NOTĂ: Conectați două fire de aceeași culoare.

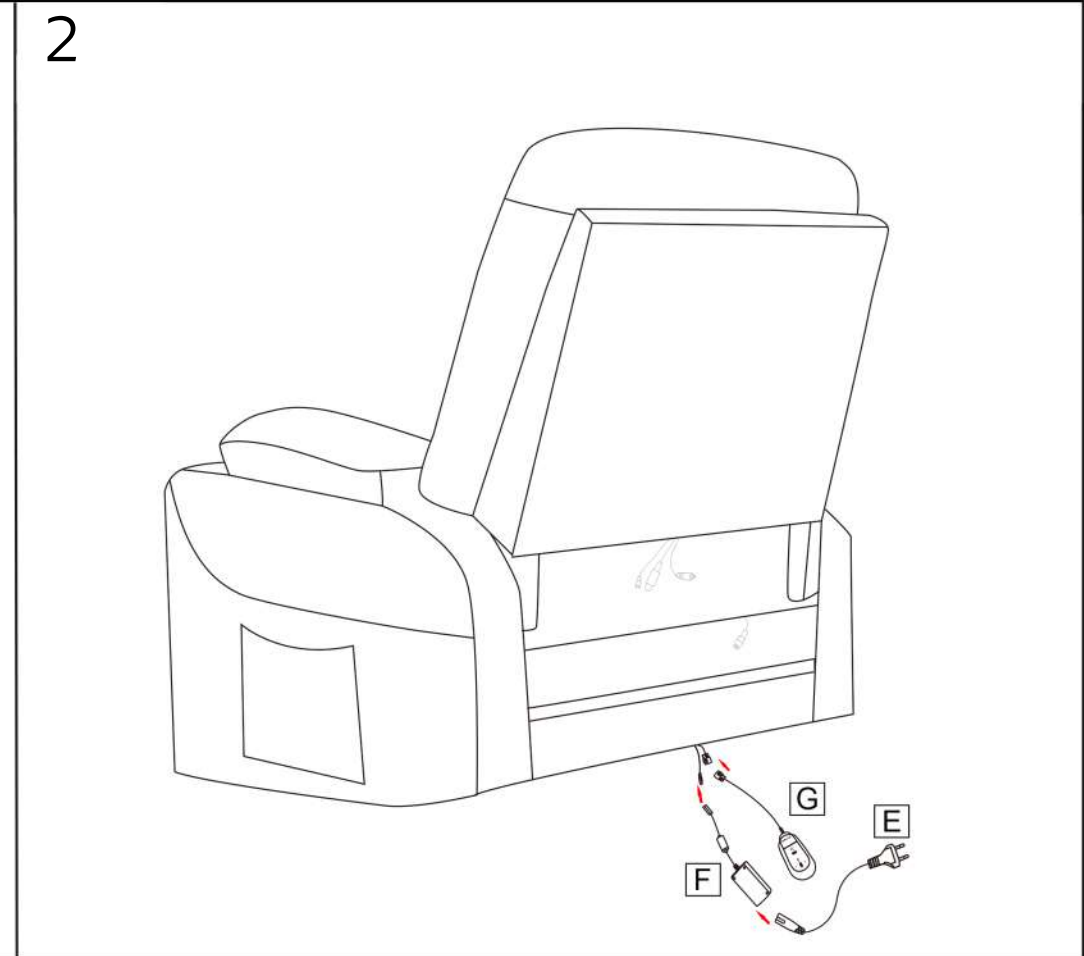
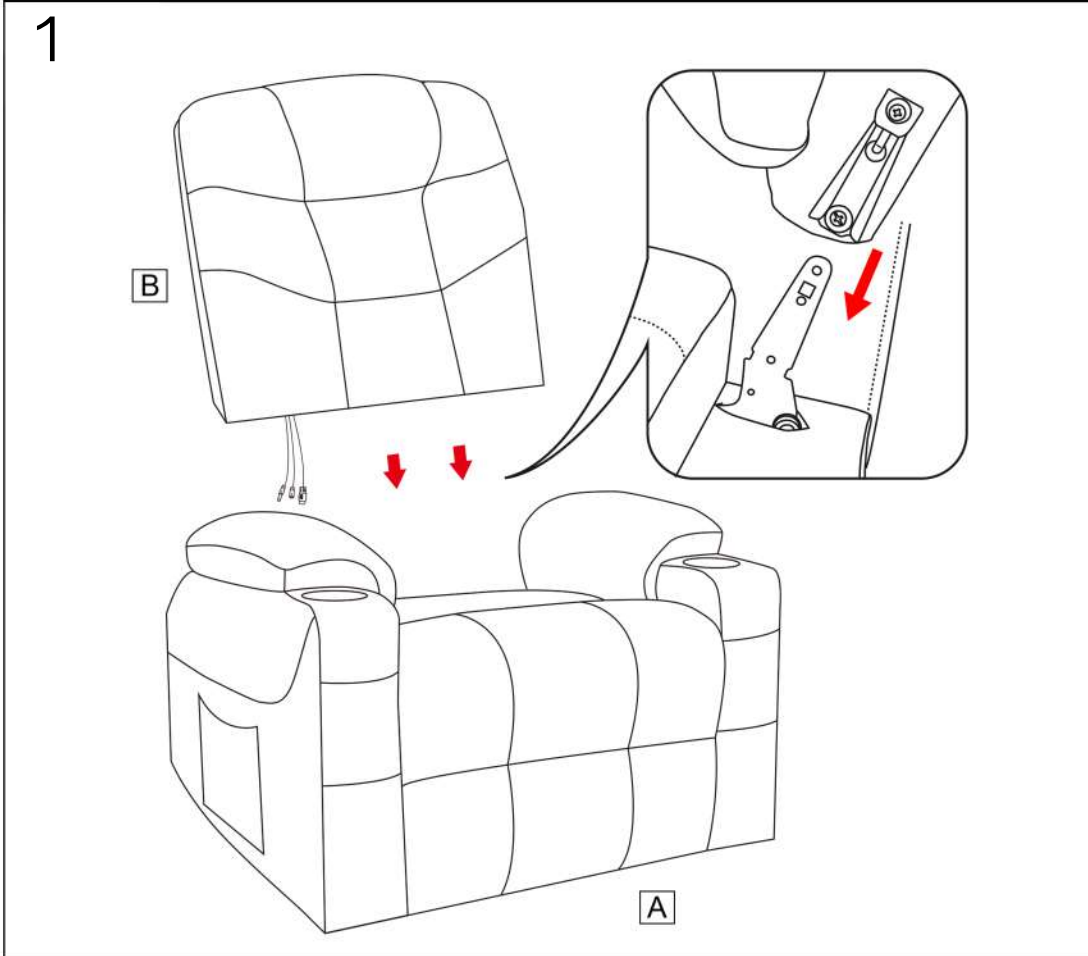
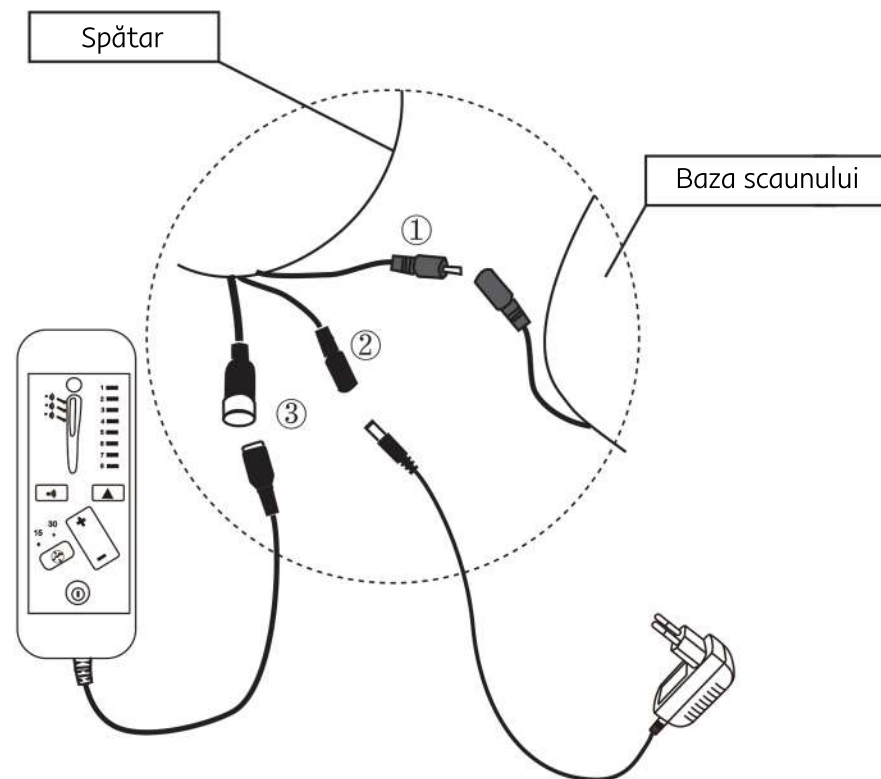
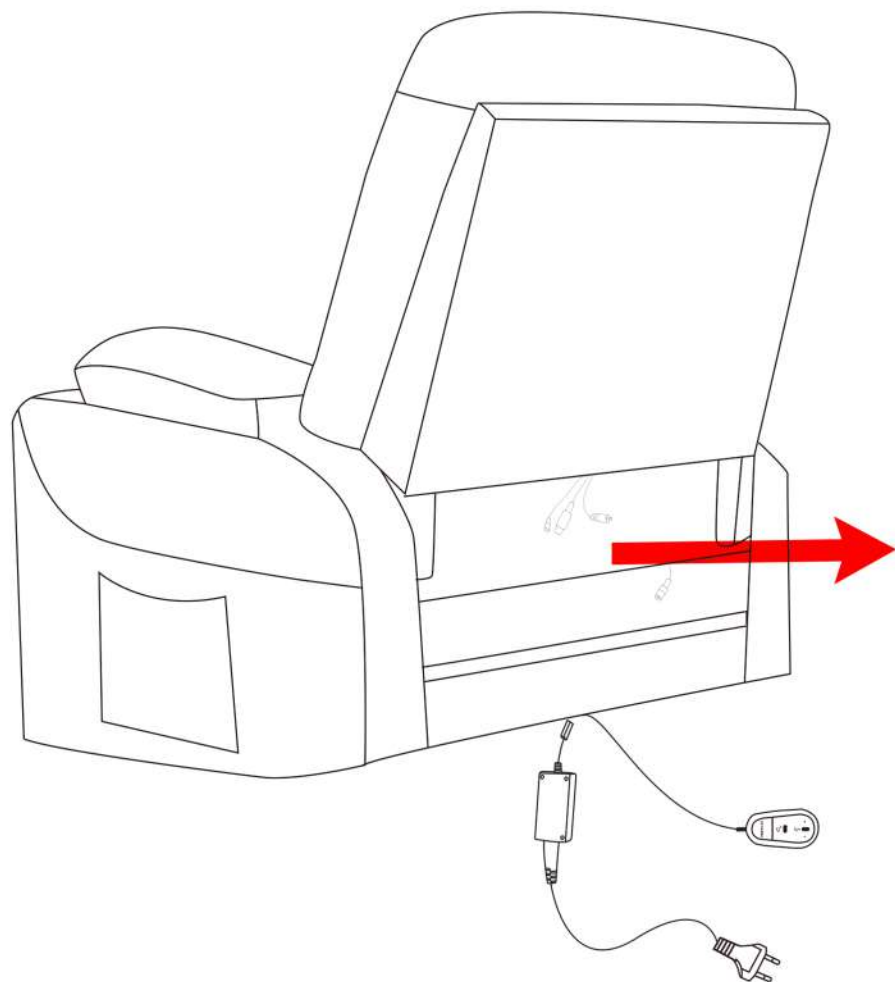

Cum să îl înclinați?

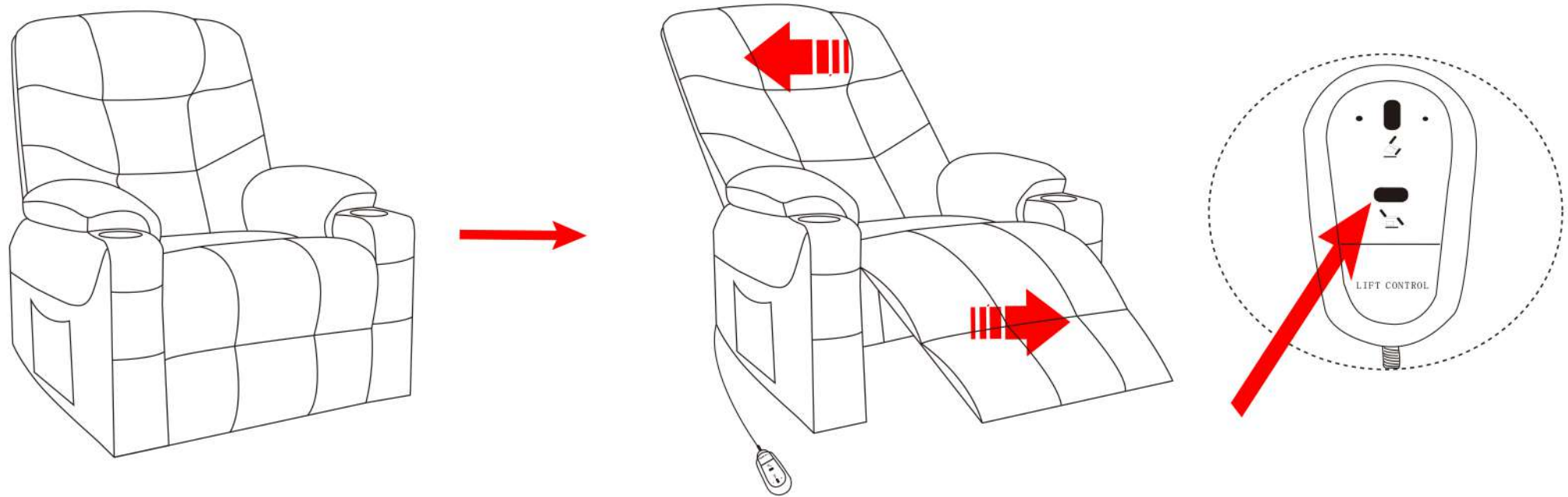

Cum să scoateți zăvorul suportului pentru picioare?

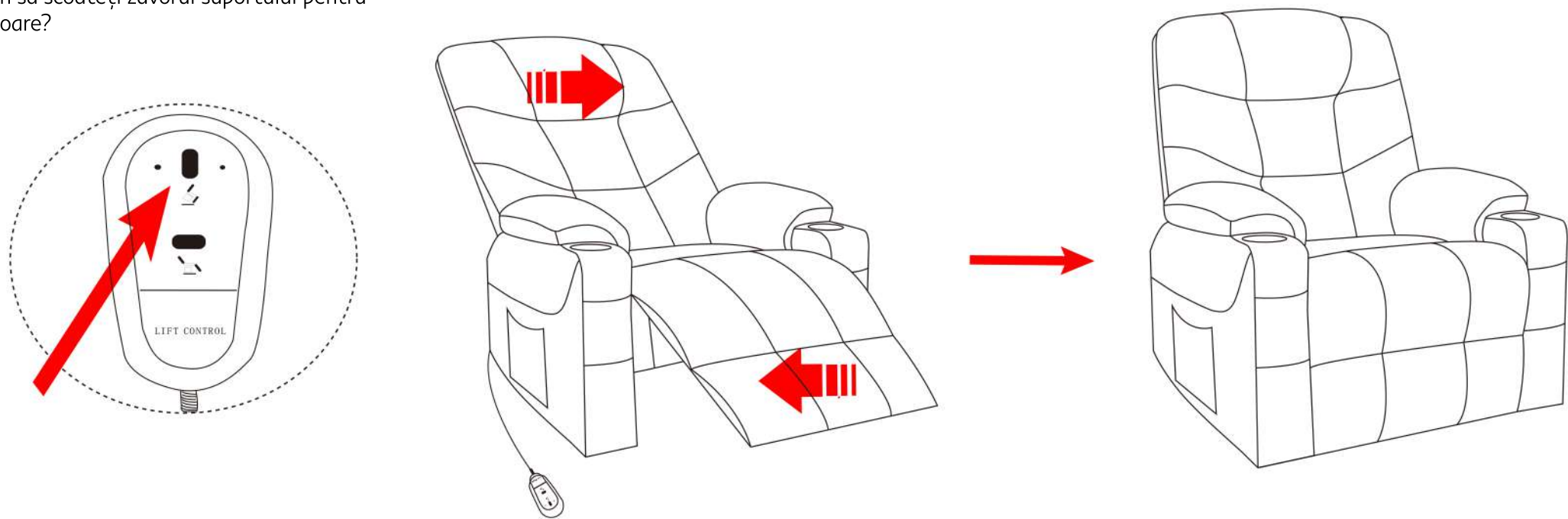

Cum să ridicați?

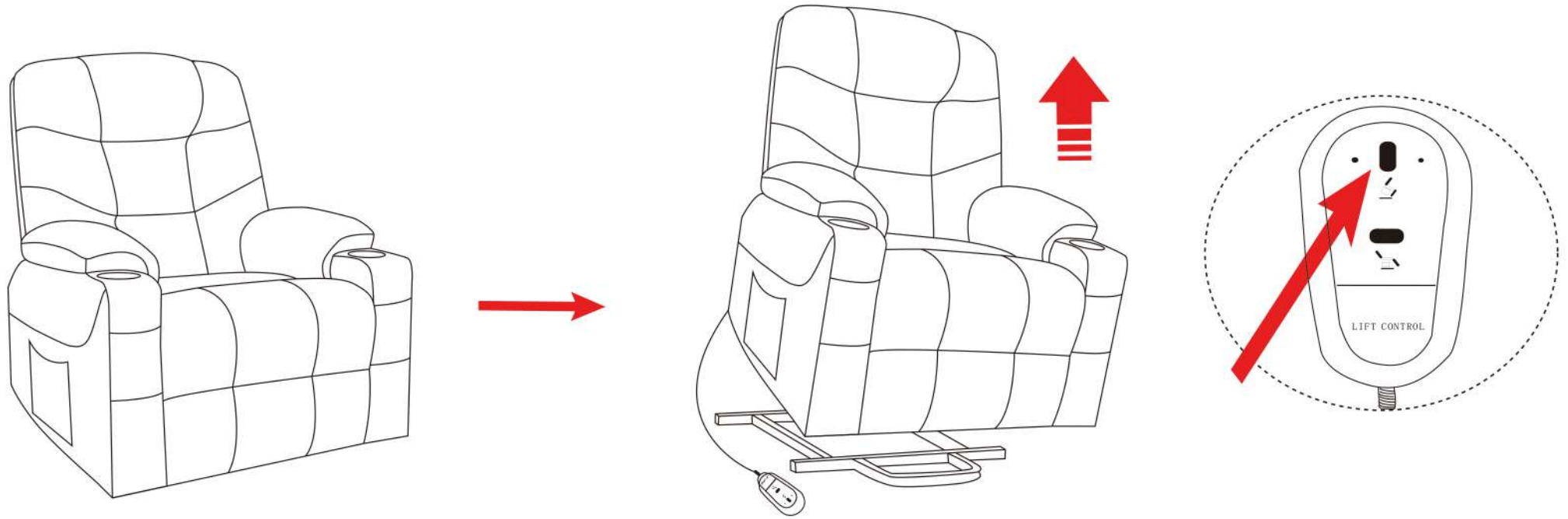

Cum să cobori?

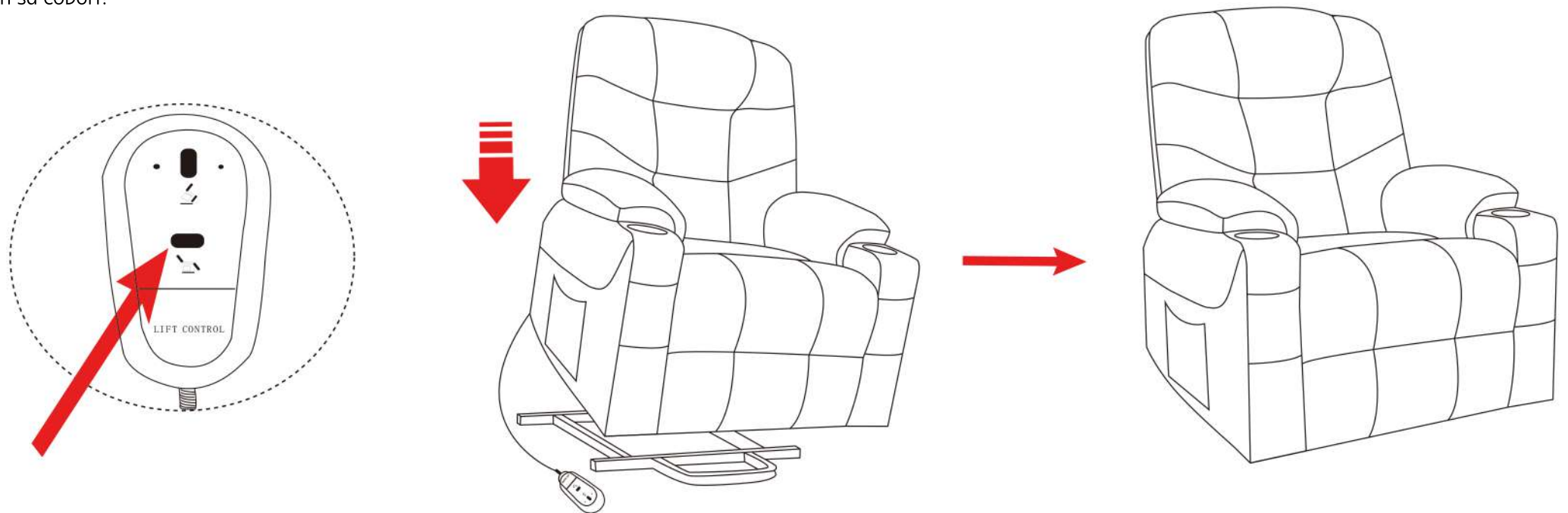

Instrucțiuni de asamblare a înclinătorului de masaj

Cum se utilizează telecomanda?

